



HEIDENHAIN



Product Overview

Interface Electronics

November 2014

Interface electronics

Interface electronics from HEIDENHAIN adapt the encoder signals to the interface of the subsequent electronics. They are used when the subsequent electronics cannot directly process the output signals from HEIDENHAIN encoders, or if additional interpolation of the signals is necessary.

HEIDENHAIN interface electronics are available in various mechanical designs.

Box design

Because of their high IP 65 degree of protection, interface electronics with a box design are well suited for a rough industrial environment, for example where machine tools operate. The inputs and outputs are equipped with robust M23 and M12 connecting elements. The stable cast-metal housing offers protection against physical damage as well as against electrical interference.

The EXE/IBV 100 series distinguishes itself from the EXE/IBV 600 series primarily in its compact dimensions.



E.g. IBV 100

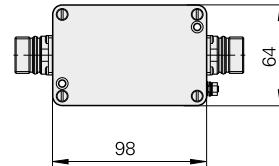

E.g. IBV 600

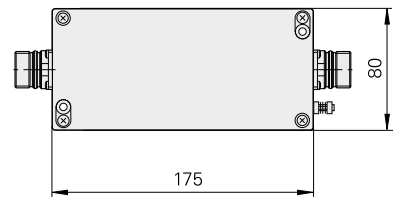

Plug design

The interface electronics with a plug design save a great deal of space: there is room for the entire interpolation and digitizing electronics in an extended D-sub connector housing. This offers protection against physical damage (IP 40 protection) and electrical interference.

Appropriate accessory parts can be used to firmly attach the connecting elements, and stack several connectors on top of each other.



E.g. APE 371

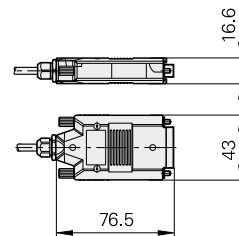

In the *Evaluation Electronics for Metrology Applications* you will find more products for signal adjustment:

- MSE 1000 – modular evaluation unit for multipoint inspection apparatuses
- EIB 700 – with four inputs and Ethernet interface
- The IK 220 – PC counter card for two axes

Version for integration

There are also versions of the interface electronics intended for integration in existing electronics. These pluggable boards must be protected against electrical and physical influences.

The **IDP** series consists of pure interpolation and digitizing electronics, and is intended for integration as input assemblies in non-HEIDENHAIN electronics.



IDP 100

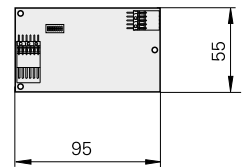

Top-hat rail design

The interface electronics for top-hat rail mounting are suited for operation in an electrical cabinet with simple fastening on a standard DIN rail.



Gateway

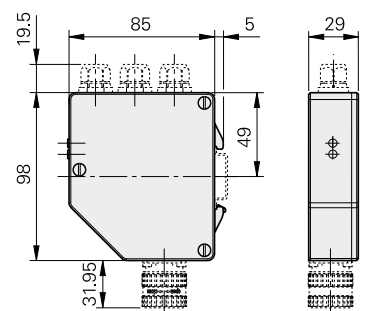

This Product Overview supersedes all previous editions, which thereby become invalid. The basis for ordering from HEIDENHAIN is always the Product Overview valid when the contract is made.

Selection guide

Input signals of the interface electronics

Interface electronics from HEIDENHAIN can be connected to encoders with sinusoidal signals of 1 V_{PP} (voltage signals) or 11 μA_{PP} (current signals). Encoders with the serial interfaces EnDat or SSI can also be connected to various interface electronics.

Output signals of the interface electronics

Interface electronics with the following interfaces to the subsequent electronics are available:

- TTL square-wave pulse trains
- EnDat 2.2
- DRIVE-CLiQ
- Fanuc Serial Interface
- Mitsubishi high speed interface
- Yaskawa Serial Interface
- Profibus

Interpolation of the sinusoidal input signals

In addition to being converted, the sinusoidal encoder signals are also interpolated in the interface electronics. This permits finer measuring steps and, as a result, higher control quality and better positioning behavior.

Formation of a position value

Some interface electronics have an integrated counting function. Starting from the last reference point set, an absolute position value is formed when the reference mark is traversed, and is transferred to the subsequent electronics.

Example of 5-fold interpolation

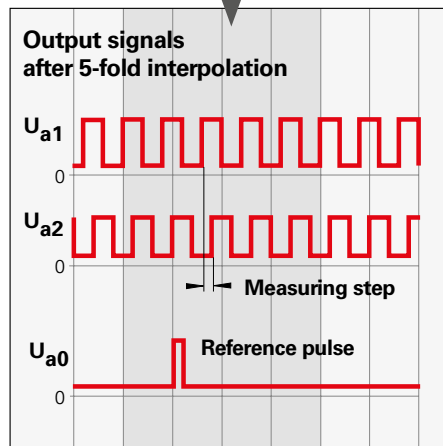
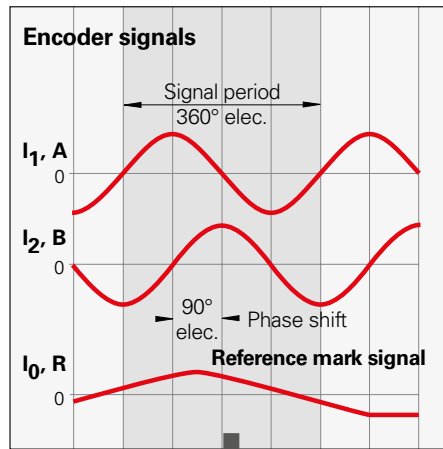

Outputs	
Interface	Quantity
TTL	1
TTL/1 V _{PP} Adjustable	2
EnDat 2.2	1
DRIVE-CLiQ	1
Fanuc Serial Interface	1
Mitsubishi high speed interface	1
Yaskawa serial interface	1
PROFIBUS-DP	1

¹⁾ Switchable

DRIVE-CLiQ is a registered trademark of SIEMENS Aktiengesellschaft

The *Interfaces of HEIDENHAIN Encoders* brochure includes comprehensive descriptions of all available interfaces as well as general electrical information.

Inputs		Design – Protection class	Interpolation ¹⁾ or subdivision	Model
Interface	Quantity			
~ 1 V _{PP}	1	Box design – IP 65	5/10-fold	IBV 101
			20/25/50/100-fold	IBV 102
			Without interpolation	IBV 600
			25/50/100/200/400-fold	IBV 660B
		Plug design – IP 40	5/10/20/25/50/100-fold	APE 371
		Version for integration – IP 00	5/10-fold	IDP 181
			20/25/50/100-fold	IDP 182
~ 11 μA _{PP}	1	Box design – IP 65	5/10-fold	EXE 101
			20/25/50/100-fold	EXE 102
			Without/5-fold	EXE 602E
			25/50/100/200/400-fold	EXE 660B
		Version for integration – IP 00	5-fold	IDP 101
~ 1 V _{PP}	1	Box design – IP 65	2-fold	IBV 6072
			5/10-fold	IBV 6172
			5/10-fold and 20/25/50/100-fold	IBV 6272
~ 1 V _{PP}	1	Box design – IP 65	≤ 16384-fold subdivision	EIB 192
	2	Plug design – IP 40	≤ 16384-fold subdivision	EIB 392
		Box design – IP 65	≤ 16384-fold subdivision	EIB 1512
EnDat 2.2	1	Box design – IP 65	–	EIB 2391 S
~ 1 V _{PP}	1	Box design – IP 65	≤ 16384-fold subdivision	EIB 192 F
		Plug design – IP 40	≤ 16384-fold subdivision	EIB 392 F
	2	Box design – IP 65	≤ 16384-fold subdivision	EIB 1592 F
~ 1 V _{PP}	1	Box design – IP 65	≤ 16384-fold subdivision	EIB 192 M
		Plug design – IP 40	≤ 16384-fold subdivision	EIB 392 M
	2	Box design – IP 65	≤ 16384-fold subdivision	EIB 1592 M
EnDat 2.2 ²⁾	1	Plug design – IP 40	–	EIB 3391 Y
EnDat 2.1; EnDat 2.2	1	Top-hat rail design	–	PROFIBUS Gateway

²⁾ Only LIC 4100 with 5 nm measuring step, LIC 2100 with 50 nm and 100 nm measuring steps

For more information

For more detailed information, mounting instructions, technical specifications and exact dimensions, please refer to our brochures and Product Information data sheets, or visit us on the Internet at www.heidenhain.de.

The *Interfaces of HEIDENHAIN Encoders* brochure includes comprehensive descriptions of all available interfaces as well as general electrical information.

In the *Evaluation Electronics for Metrology Applications* catalog you will find more products for signal adjustment.



Catalog
Interfaces of HEIDENHAIN Encoders



Catalog
Evaluation Electronics for Metrology Applications



Product Information
APE 371



Product Information
EIB 192



Product Information
EIB 392



Product Information
EIB 1500 Series

Contents:
EIB 1512
EIB 1592F
EIB 1592M



Product Information
EIB 2391S



Product Information
EIB 3391Y



Product Information
ExN 100 Series

Contents:
EXE 101
EXE 102



Product Information
ExN 600 Series

Contents:
EXE 602 E
EXE 660 B



Product Information
Gateway



Product Information
IBV 100 Series

Contents:
IBV 101
IBV 102



Product Information
IBV 600 Series

Contents:
IBV 600
IBV 606
IBV 660 B



Product Information
IBV 6000 Series

Contents:
IBV 6072
IBV 6172
IBV 6272



Product Information
IDP 100 Series

Contents:
IDP 101
IDP 181
IDP 182

HEIDENHAIN

DR. JOHANNES HEIDENHAIN GmbH

Dr.-Johannes-Heidenhain-Straße 5

83301 Traunreut, Germany

☎ +49 8669 31-0

FAX +49 8669 32-5061

E-mail: info@heidenhain.de

www.heidenhain.de

Vollständige und weitere Adressen siehe www.heidenhain.de
For complete and further addresses see www.heidenhain.de

DE	HEIDENHAIN Vertrieb Deutschland 83301 Traunreut, Deutschland ☎ 08669 31-3132 FAX 08669 32-3132 E-Mail: hd@heidenhain.de	ES	FARRESA ELECTRONICA S.A. 08028 Barcelona, Spain www.farresa.es	PL	APS 02-384 Warszawa, Poland www.heidenhain.pl
	HEIDENHAIN Technisches Büro Nord 12681 Berlin, Deutschland ☎ 030 54705-240	FI	HEIDENHAIN Scandinavia AB 01740 Vantaa, Finland www.heidenhain.fi	PT	FARRESA ELECTRÓNICA, LDA. 4470 - 177 Maia, Portugal www.farresa.pt
	HEIDENHAIN Technisches Büro Mitte 07751 Jena, Deutschland ☎ 03641 4728-250	FR	HEIDENHAIN FRANCE sarl 92310 Sèvres, France www.heidenhain.fr	RO	HEIDENHAIN Reprezentantă Romania Braşov, 500407, Romania www.heidenhain.ro
	HEIDENHAIN Technisches Büro West 44379 Dortmund, Deutschland ☎ 0231 618083-0	GB	HEIDENHAIN (G.B.) Limited Burgess Hill RH15 9RD, United Kingdom www.heidenhain.co.uk	RS	Serbia → BG
	HEIDENHAIN Technisches Büro Südwest 70771 Leinfelden-Echterdingen, Deutschland ☎ 0711 993395-0	GR	MB Milionis Vassilis 17341 Athens, Greece www.heidenhain.gr	RU	OOO HEIDENHAIN 115172 Moscow, Russia www.heidenhain.ru
	HEIDENHAIN Technisches Büro Südost 83301 Traunreut, Deutschland ☎ 08669 31-1345	HK	HEIDENHAIN LTD Kowloon, Hong Kong E-mail: sales@heidenhain.com.hk	SE	HEIDENHAIN Scandinavia AB 12739 Skärholmen, Sweden www.heidenhain.se
		HR	Croatia → SL	SG	HEIDENHAIN PACIFIC PTE LTD Singapore 408593 www.heidenhain.com.sg
AR	NAKASE SRL. B1653AOX Villa Ballester, Argentina www.heidenhain.com.ar	HU	HEIDENHAIN Kereskedelmi Képviselet 1239 Budapest, Hungary www.heidenhain.hu	SK	KOPRETINA TN s.r.o. 91101 Trenčín, Slovakia www.kopretina.sk
AT	HEIDENHAIN Techn. Büro Österreich 83301 Traunreut, Germany www.heidenhain.de	ID	PT Servitama Era Toolsindo Jakarta 13930, Indonesia E-mail: ptset@group.gts.co.id	SL	NAVO d.o.o. 2000 Maribor, Slovenia www.heidenhain.si
AU	FCR MOTION TECHNOLOGY PTY LTD 3026 Victoria, Australia E-mail: sales@fcrmotion.com	IL	NEUMO VARGUS MARKETING LTD. Tel Aviv 61570, Israel E-mail: neumo@neumo-vargus.co.il	TH	HEIDENHAIN (THAILAND) LTD Bangkok 10250, Thailand www.heidenhain.co.th
BE	HEIDENHAIN NV/SA 1760 Roosdaal, Belgium www.heidenhain.be	IN	HEIDENHAIN Optics & Electronics India Private Limited Chetpet, Chennai 600 031, India www.heidenhain.in	TR	T&M Mühendislik San. ve Tic. LTD. ŞTİ. 34775 Y. Dudullu – Ümraniye-Istanbul, Turkey www.heidenhain.com.tr
BG	ESD Bulgaria Ltd. Sofia 1172, Bulgaria www.esd.bg	IT	HEIDENHAIN ITALIANA S.r.l. 20128 Milano, Italy www.heidenhain.it	TW	HEIDENHAIN Co., Ltd. Taichung 40768, Taiwan R.O.C. www.heidenhain.com.tw
BR	DIADUR Indústria e Comércio Ltda. 04763-070 – São Paulo – SP, Brazil www.heidenhain.com.br	JP	HEIDENHAIN K.K. Tokyo 102-0083, Japan www.heidenhain.co.jp	UA	Gertner Service GmbH Büro Kiev 01133 Kiev, Ukraine www.heidenhain.ua
BY	GERTNER Service GmbH 220026 Minsk, Belarus www.heidenhain.by	KR	HEIDENHAIN Korea LTD. Gasan-Dong, Seoul, Korea 153-782 www.heidenhain.co.kr	US	HEIDENHAIN CORPORATION Schaumburg, IL 60173-5337, USA www.heidenhain.com
CA	HEIDENHAIN CORPORATION Mississauga, Ontario L5T2N2, Canada www.heidenhain.com	MX	HEIDENHAIN CORPORATION MEXICO 20290 Aguascalientes, AGS., Mexico E-mail: info@heidenhain.com	VE	Maquinaria Diekmann S.A. Caracas, 1040-A, Venezuela E-mail: purchase@diekmann.com.ve
CH	HEIDENHAIN (SCHWEIZ) AG 8603 Schwerzenbach, Switzerland www.heidenhain.ch	MY	ISOSERVE SDN. BHD. 43200 Balakong, Selangor E-mail: sales@isoserve.com.my	VN	AMS Co. Ltd HCM City, Vietnam E-mail: davidgoh@amsvn.com
CN	DR. JOHANNES HEIDENHAIN (CHINA) Co., Ltd. Beijing 101312, China www.heidenhain.com.cn	NL	HEIDENHAIN NEDERLAND B.V. 6716 BM Ede, Netherlands www.heidenhain.nl	ZA	MAFEMA SALES SERVICES C.C. Midrand 1685, South Africa www.heidenhain.co.za
CZ	HEIDENHAIN s.r.o. 102 00 Praha 10, Czech Republic www.heidenhain.cz	NO	HEIDENHAIN Scandinavia AB 7300 Orkanger, Norway www.heidenhain.no		
DK	TPTEKNIK A/S 2670 Greve, Denmark www.tp-gruppen.dk	PH	MACHINEBANKS' CORPORATION Quezon City, Philippines 1113 E-mail: info@machinebanks.com		

